

KONOLD TÜREN VIELFALT







Made by KÖNOLD in Katzenstein Germany

KÖNOLD Türen ist ein mittelständisches Unternehmen, das nun bereits in 3. Generation mit 150 Mitarbeitern hochwertige Innentüren für Ihr Zuhause fertigt.

Idyllisch gelegen in Katzenstein, auf der schwäbischen Alb hat sich ein hochmodernes Türenwerk mit Schreinerei entwickelt. Dort vereinen wir tagtäglich die Vorteile industrieller Fertigung und unserer individuellen Handwerksleistung.

JEDES MASS AB STÜCKZAHL 1

Wir fertigen Türen in jeder auf dem Markt verfügbaren Holzart ab Stückzahl 1

TÜRENMASSE:

- Breite bis 2200 mm (am Stück)
- Höhen bis 3500 mm (am Stück)

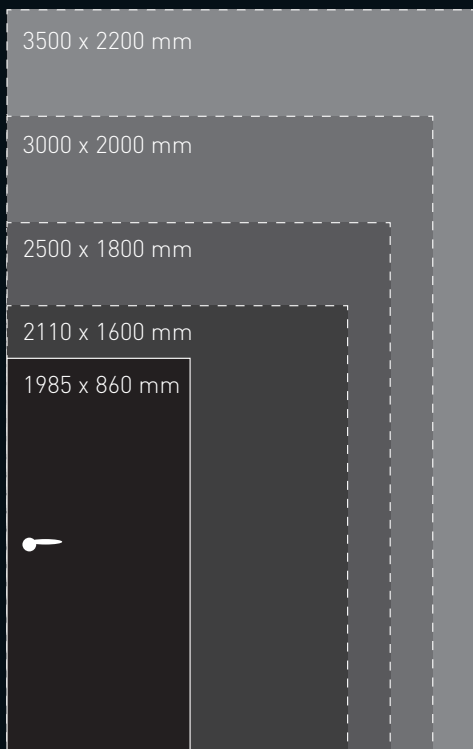

ZARGENMASSE:

- Breite bis 3500 mm (am Stück)
- Höhen bis 3500 mm (am Stück)

BEKLEIDUNGSBREITEN

- Kantig von 50-140 mm im 5 mm Rhythmus
- Soft, Soft2, Befä und Beka von 60-140 mm im 5 mm Rhythmus
- Bebo in 80 mm

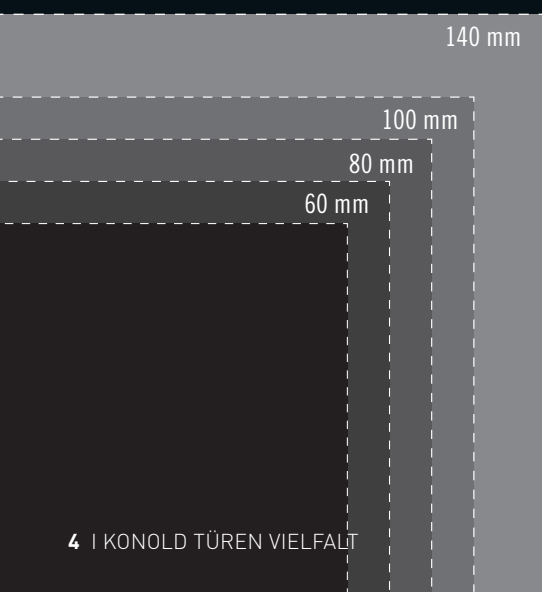

MASSIVES RAHMENHOLZ

Massiver Fichte Tanne Rahmen
jede Türe 5 cm kürzbar



**MASSIVE
METALLANKER-PLATTE**

Für mehr Sicherheit,
Standard in jeder Zarge



RAL HANDLACKIERTE ZARGEN

werden generell vormontiert geliefert

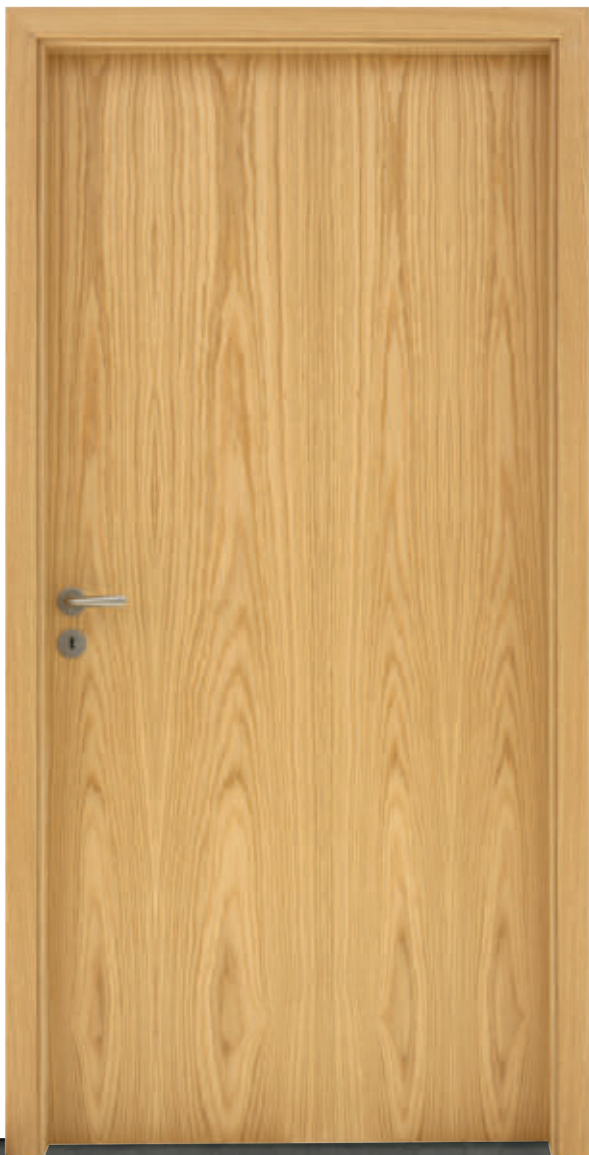





JEDES FURNIER
IST SO EINMALIG
WIE SIE SELBST.

Glatte Türen



Oberfläche: Eiche Astig weiss mattlack
Modell: G00
Zarge: Eiche Astig weiss mattlack Eckig

Oberfläche: Landeiche
Modell: G00
Zarge: Eiche Astig Soft



Oberfläche: Almeiche mattlack
Modell: G00 nur Drückerlochbohrung
Zarge: Almeiche mattlack Eckig



Oberfläche: Altholz Eiche geölt
Modell: G00
Zarge: Altholz Eiche geölt Eckig



Oberfläche: Eiche Sägeschliff
Modell: G00
Zarge: Eiche Sägeschliff Eckig





Detail Eiche Sägeschliff

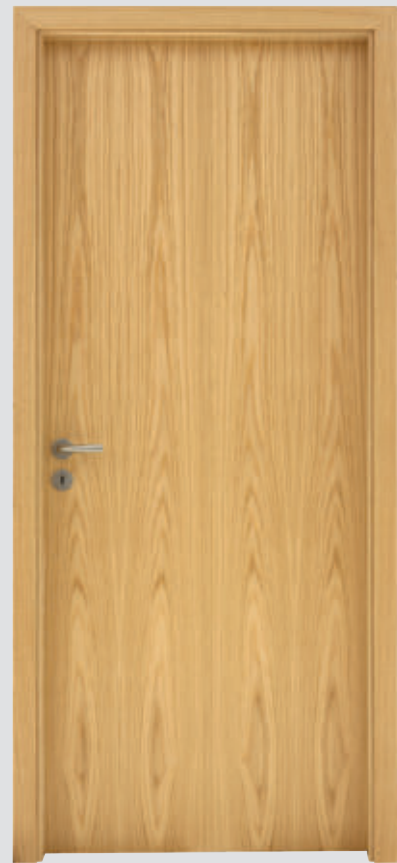

Oberfläche: Eiche Amerikanisch
Modell: G00
Zarge: Eiche Amerikanisch Soft



Oberfläche: Eiche KP 43
Modell: G00
Zarge: Eiche KP43 Soft

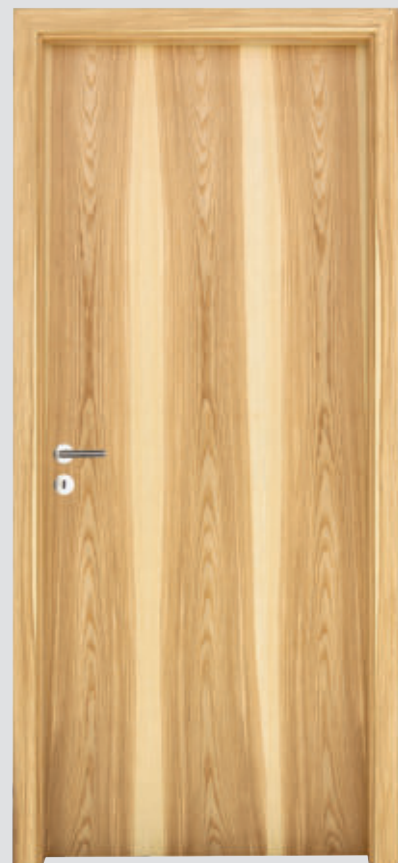

Oberfläche: Kernesche
Modell: G00
Zarge: Kernesche Soft



Oberfläche: Altholz Fichte geölt
Modell: G00
Zarge: Altholz Fichte geölt Eckig



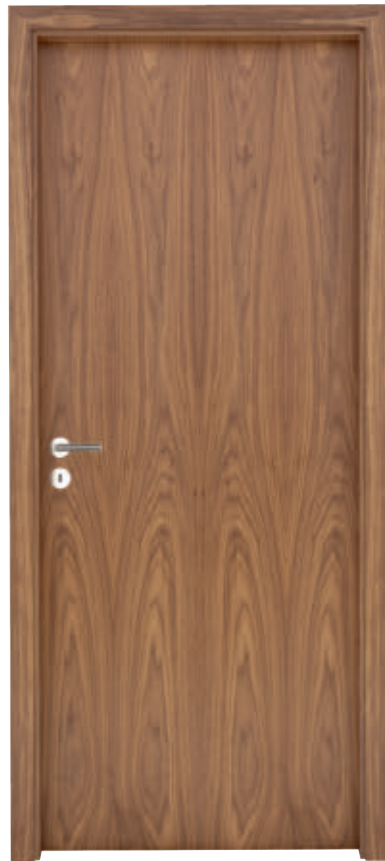

Oberfläche: Amerikanisch Nussbaum
Modell: G00
Zarge: Amerikanisch Nussbaum Soft



Oberfläche: Esche
Modell: G00
Zarge: Esche Soft



Esche OFPO 5859

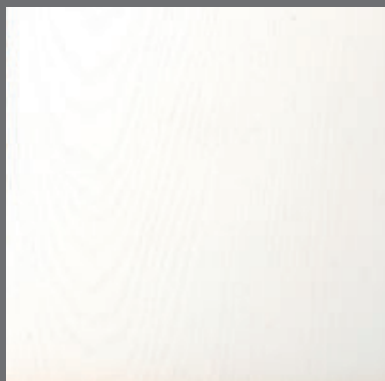

Esche GEPO 5859

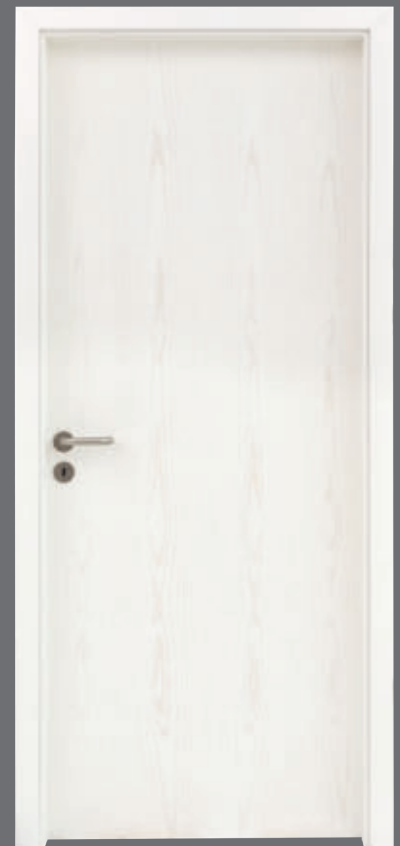

Oberfläche: Esche OFPO 5859
Modell: G00
Zarge: Esche OFPO 5859 Soft

Furniervielfalt





Intarsien



Drücker: KOHO 140 Black Stone



Oberfläche: Titan / Saturn
Modell: Marenso 01
Zarge: Titan Soft



Detail: Vavonamaser
Drücker: KOHO 136



Oberfläche: Canadisch Ahorn / Vavonamaser
Modell: Imola 00
Zarge: Canadisch Ahorn Bebo



Oberfläche: Wurmahorn
Modell: Naomi 01
Zarge: Wurmahorn 80 mm Bekleidung Soft

Intarsien



Oberfläche: Eiche astig weiss mattlack
Modell: Naomi 01
Zarge: Eiche astig weiss mattlack Eckig



Oberfläche: Eiche astig
Modell: Naomi 01
Zarge: Eiche Amerikanisch Soft



Oberfläche: Eiche Amerikanisch
Modell: Naomi 01
Zarge: Eiche Amerikanisch Soft

Modellvariationen

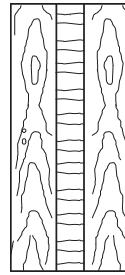

Aquila 01

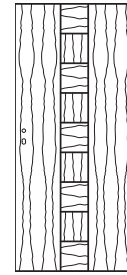

Aquila 08

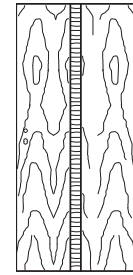

Ariva 08

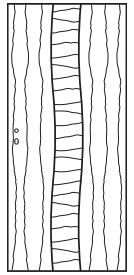

Arosa 01

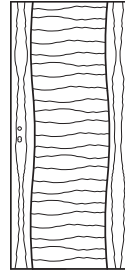

Arosa 16-01

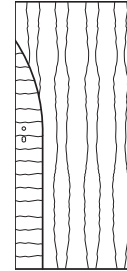

Bigera 01



Bologna 00

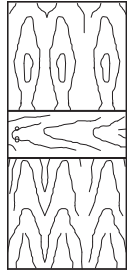

Caminar 01

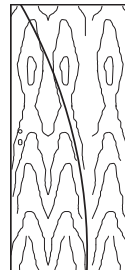

Capri 00

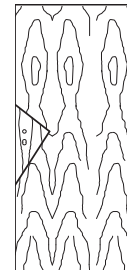

Imola 00

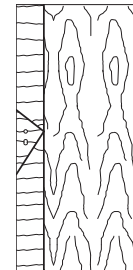

Isque 01

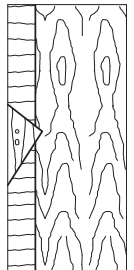

Laque 00

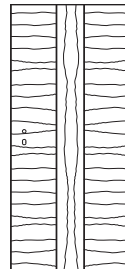

Lazia 01

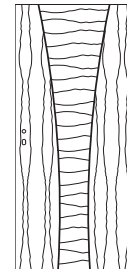

Lora 01

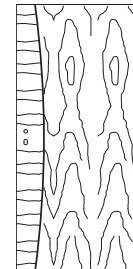

Marenso 01

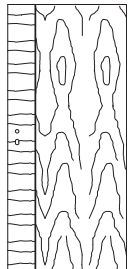

Marino 01

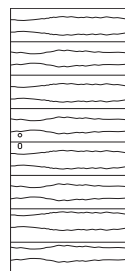

Naomi 01

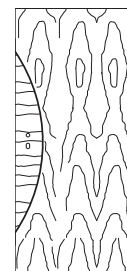

Palma 01



Palmero 00

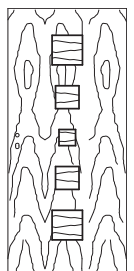

Quadra 01

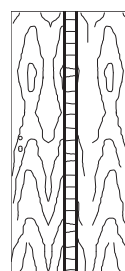

Sariva

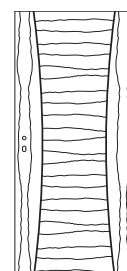

Trenso 01

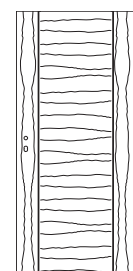

Trento 16-01

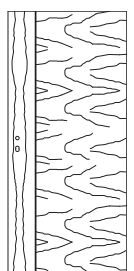

Vela 00



Oberfläche: Eiche Amerikanisch
Modell: Trento 16/01
Zarge: Eiche Amerikanisch Soft

Lichtausschnitt



Detail: Glasleiste flächenbündig FB4

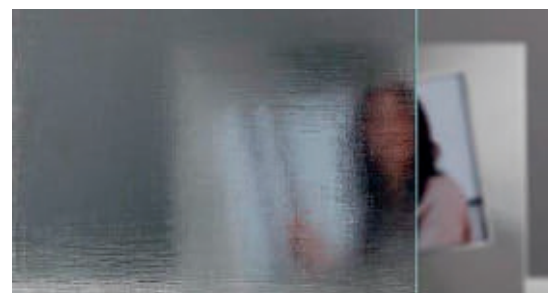

Detail: Glas Thela Weiß

Oberfläche: Kernbuche Baumstammoptik
Modell: G00 2G50 Thela (Glasleiste FB4)
Zarge: Kernbuche 80 mm Bekleidung Soft 2

Modellvariationen

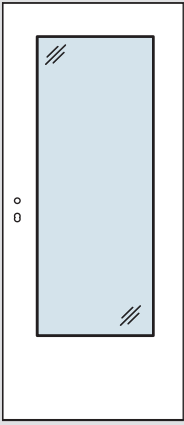

G04

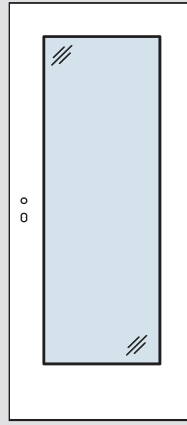

G04A

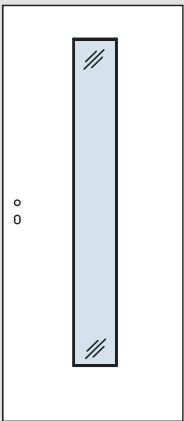

G50

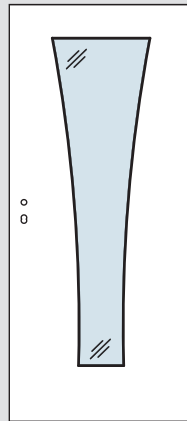

GS10

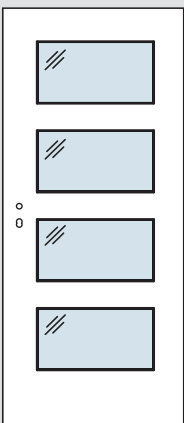

RE04

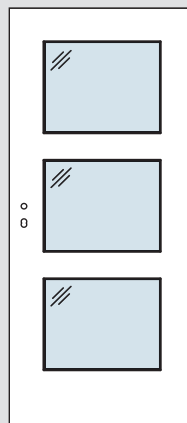

RE33

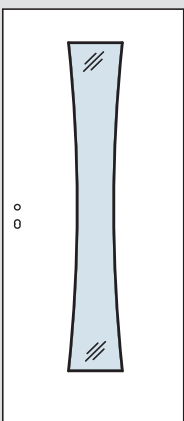

SL50

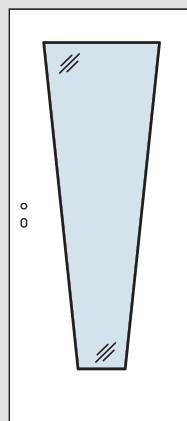

TT04

Glasseistenvielfalt

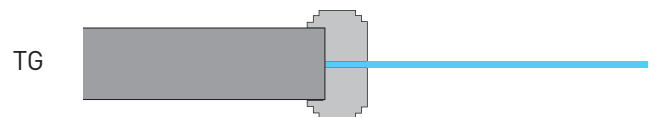
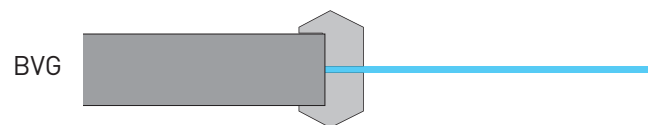
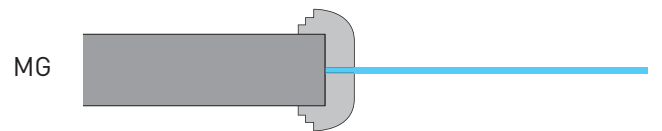
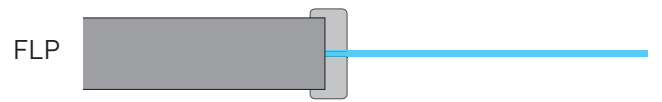
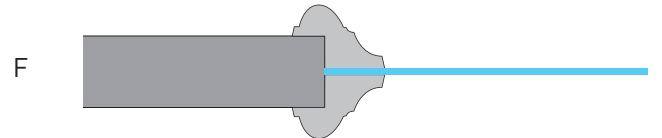
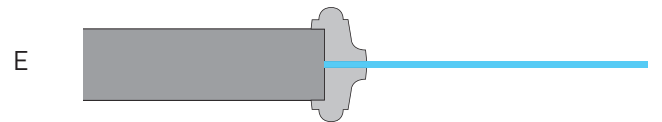
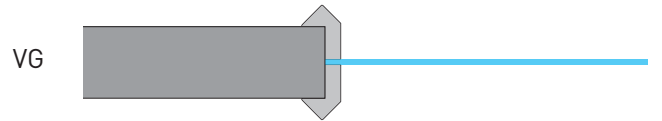
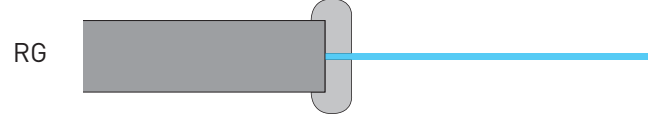
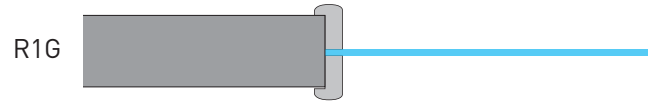
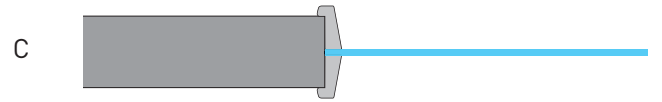

Konglas

Modellvariationen

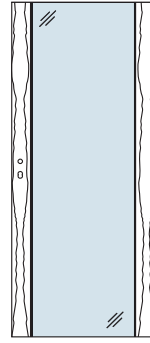

KGL 01

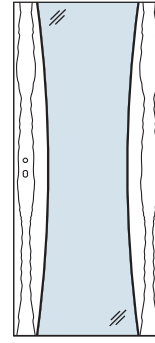

KGL 11

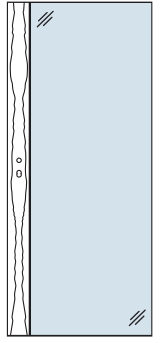

KGL 12

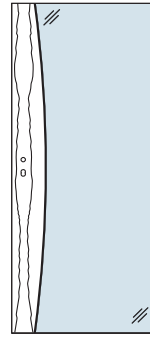

KGL 13

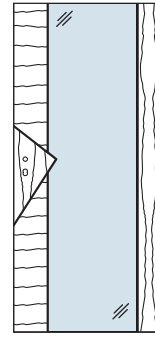

KGL 14

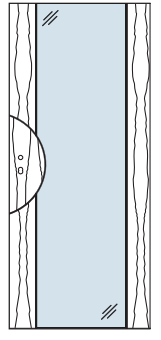

KGL 16

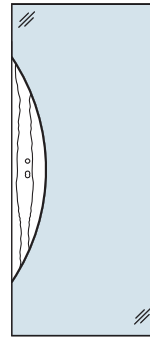

KGL 20

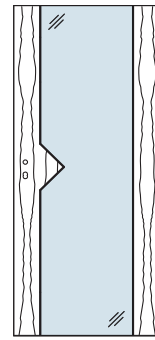

KGL 21

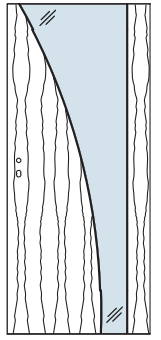

KGL 24

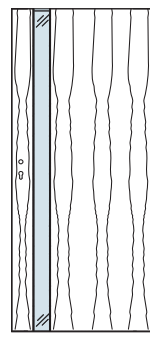

KGL 27s

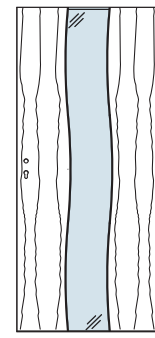

KG 30

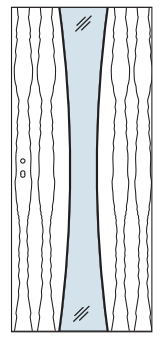

KGL 33

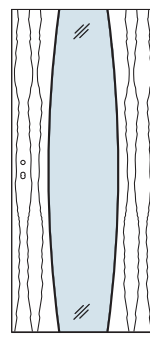

KGL 34

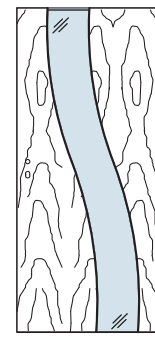

KGL 36

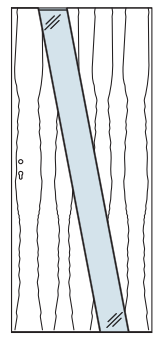

KGL 37

Oberfläche: Red Gum
Modell: KGL 43 Satinato Weißglas
Zarge: Red Gum 50 mm Eckig



Oberfläche: Imbuia
 Modell: KGL 01 Float mit Lasermotiv 23
 Zarge: RAL 9001 Bekleidung Bebo



Oberfläche: Canadisch Ahorn
 Modell: KGL01-A - Glas Float - Rille Q101 matt
 Zarge: Canadisch Ahorn Bekleidung Soft2

KGL

Glas durchgehend nicht kürzbar



KGL A

Querholz oben und unten kürzbar 15 mm



KGL B

Aluschiene unten kürzbar 15 mm

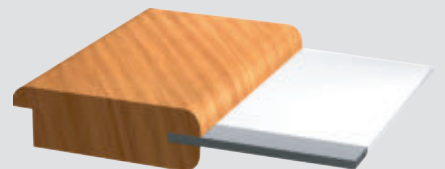

Konglas

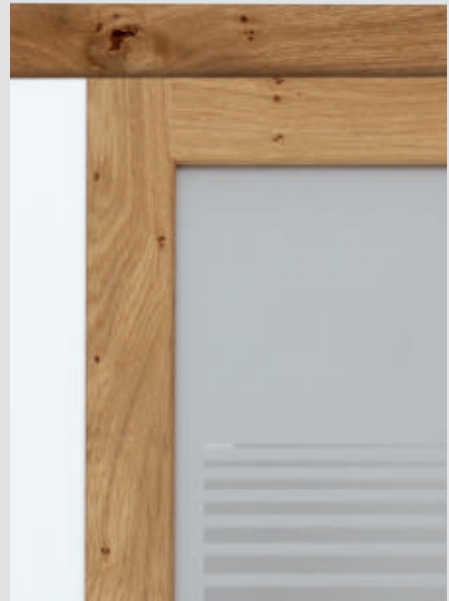

Detail: mit Querholz

Oberfläche: RAL 9010 / Eiche Astig

Modell: KGL 50/20 mit Querholz oben und unten

Glas: Grundglas Sandgestrahlt

Motiv Lea Float hell

Zarge: Eiche Astig Bekleidung Soft 2

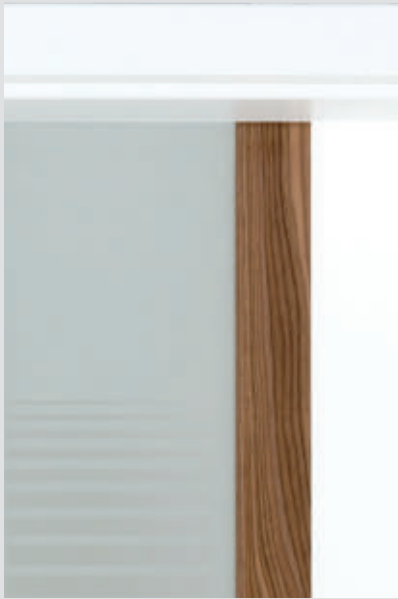

Detail: ohne Querholz



Oberfläche: RAL 9010 / Farbfurnier Venus

Modell: KGL 50/20 ohne Querholz

Glas: Grundglas Sandgestrahlt
Motiv Lea Float hell

Zarge: RAL 9010 80 mm Bekleidung Soft 2



KONOLD TÜREN,
DAS BESTE AUS
DEM SCHÖNSTEN
ROHSTOFF DER
NATUR

Landhaus



Oberfläche: RAL 9010

Modell: ALG 16 Chiemsee

Zarge: RAL 9010 Bekleidung Bebo





Oberfläche: Fichte Astig
 Modell: ALG 08 Franken
 Zarge: Fichte Astig Soft

Detail: Querstück stumpf

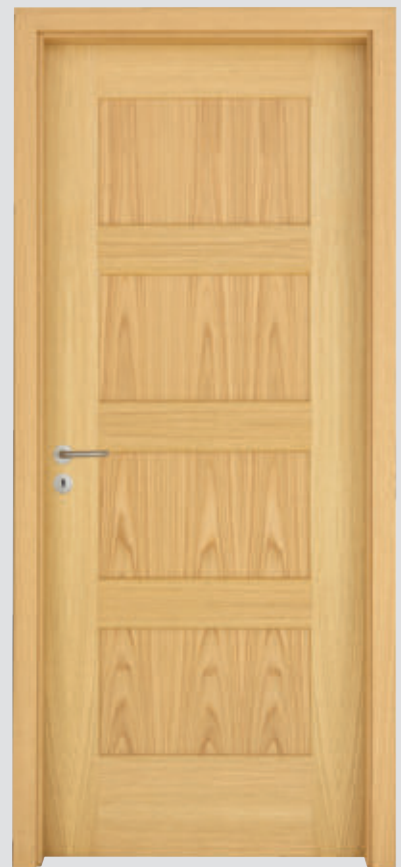
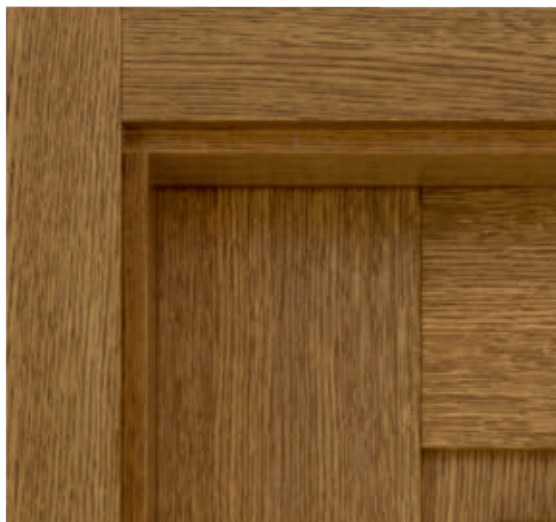

Oberfläche: Eiche Amerikanisch
 Modell: ALG 29 Franken
 Zarge: Eiche Amerikanisch Soft



Oberfläche: Eiche KP43
 Modell: ALG 25 Baden
 Zarge: Eiche KP43 Eckig
 Querstück Stumpf

Modellvariationen

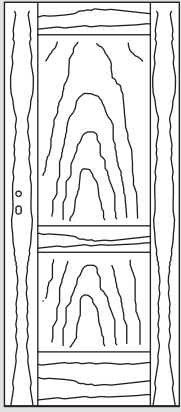

ALG 01

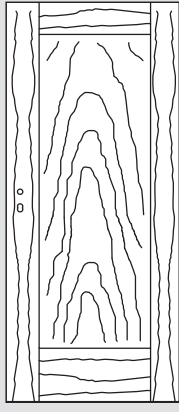

ALG 02

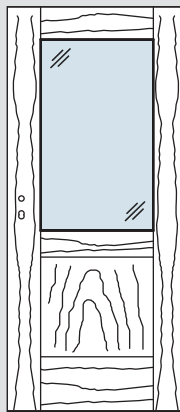

ALG 03

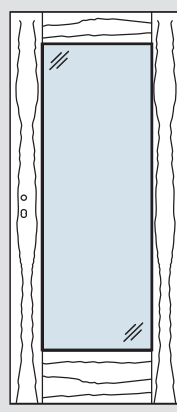

ALG 04

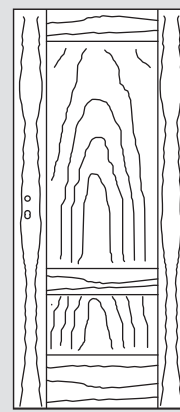

ALG 16

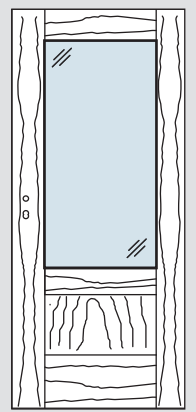

ALG 17

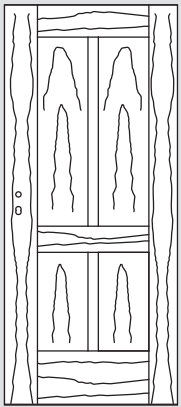

ALG 21

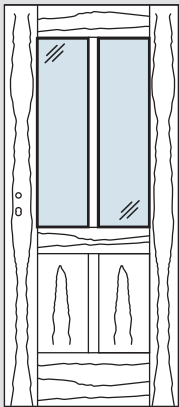

ALG 22

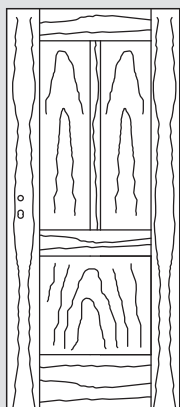

ALG 25

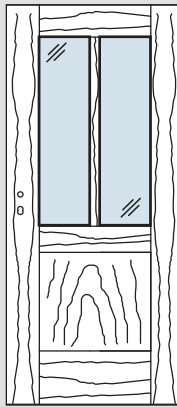

ALG 26

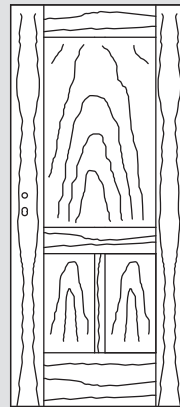

ALG 27

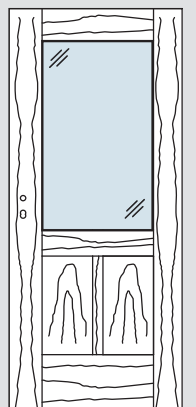

ALG 28

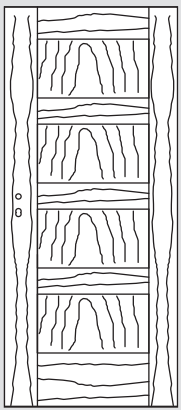

ALG 29

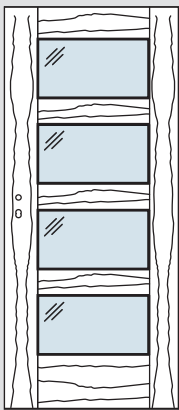

ALG 30

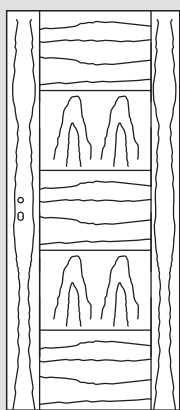

ALG 32

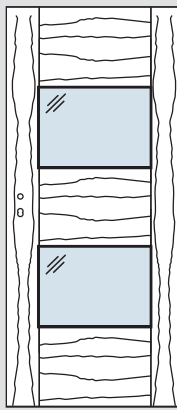

ALG 33

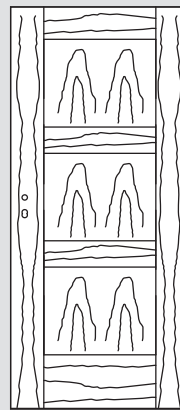

ALG 34

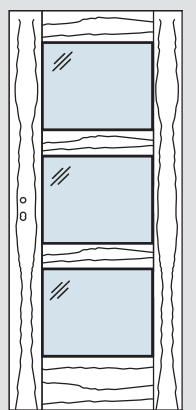

ALG 35

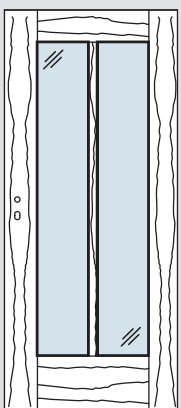

ALG 47

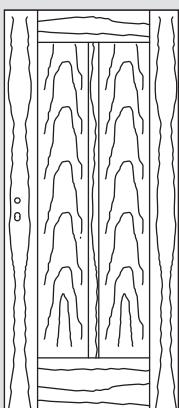

ALG 48



Oberfläche: Eiche Astig Weiss mattlack
 Modell: ALG 01 Füllung Franken
 Zarge: Eiche Astig Weiss mattlack Bekleidung Bebo



Oberfläche: Eiche Astig
 Modell: ALG 48 Füllung Franken
 Zarge: Eiche Astig Bekleidung Soft

FRANKEN

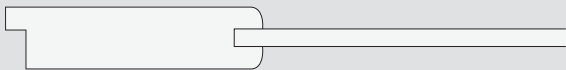

BADEN

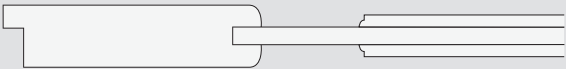

CHIEMSEE



QUERSCHNITTE

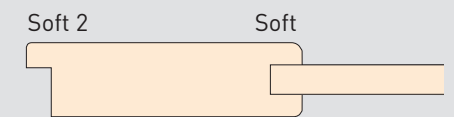
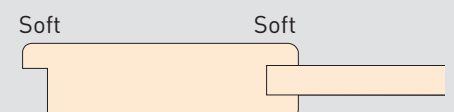
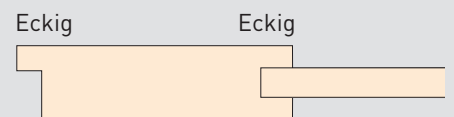

Stiltüren



Oberfläche: RAL 9010
Modell: Saarbrücken G26 Bianca -
Rand Float hell
Zarge: Sondermodell mit Rille

Modellvariationen

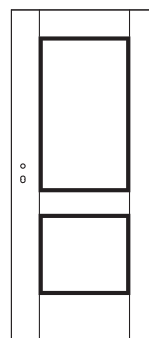

G01

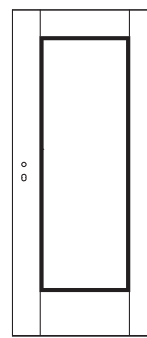

G02

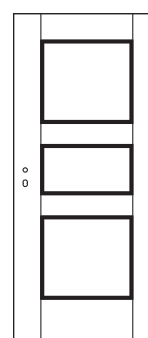

G08

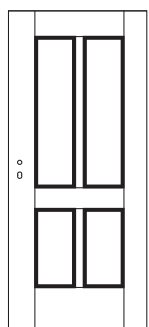

G21

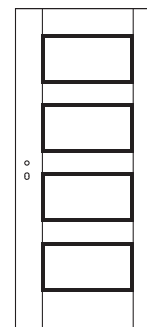

G29

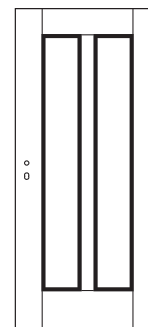

G48

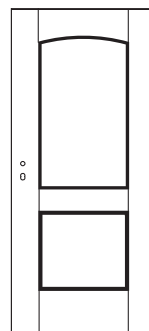

S01

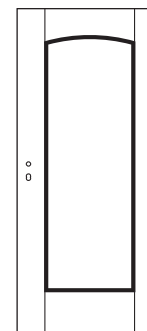

S02

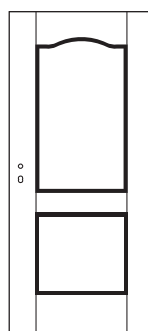

J01

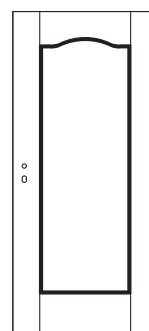

J02

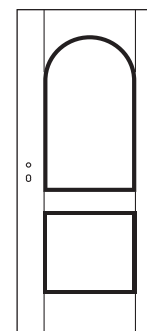

R01

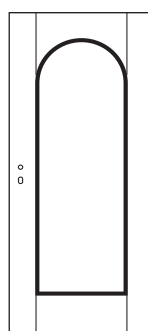

R02

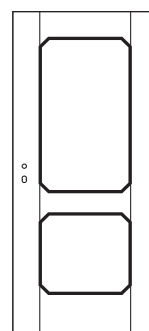

A01

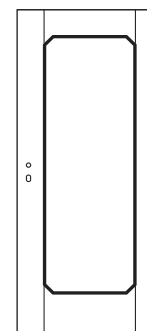

A02

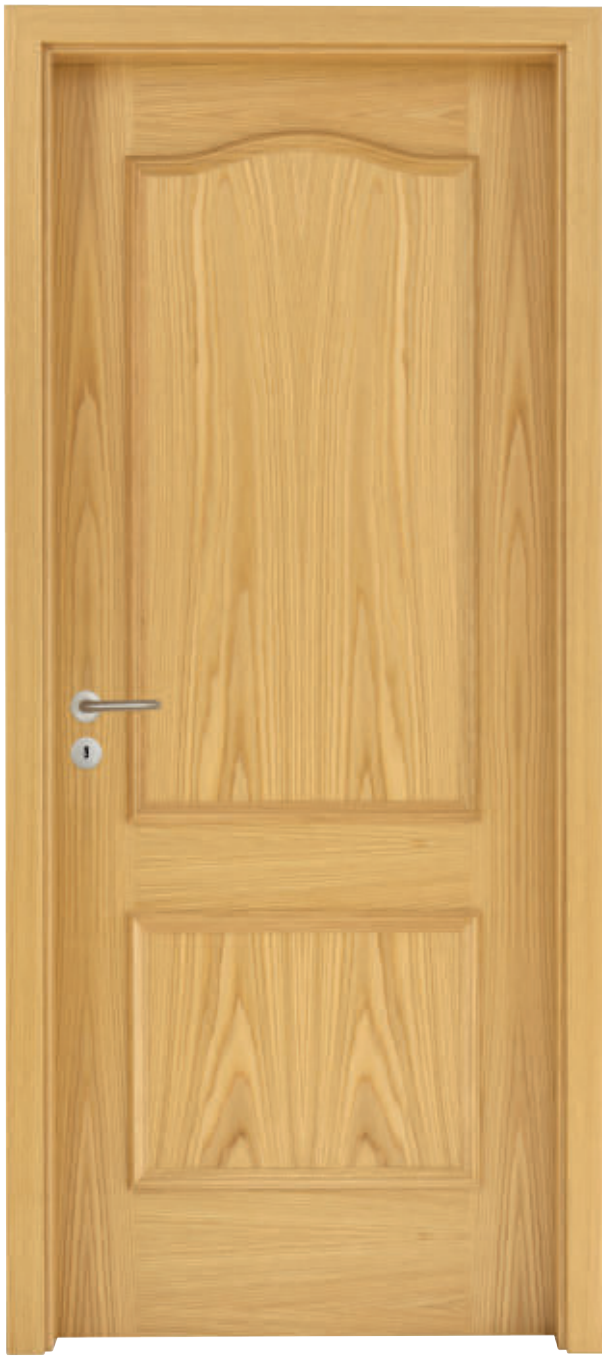

Oberfläche: Eiche Amerikanisch
 Modell: J01 Aachen
 Zarge: Eiche Amerikanisch Bekleidung Soft



Oberfläche: Buche
 Modell: G21 Saarbrücken
 Zarge: Buche Bekleidung Bebo

SAARBRÜCKEN
 durchlaufend furniert

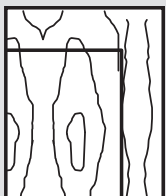

AACHEN
 auf Rahmen furniert

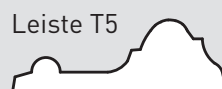
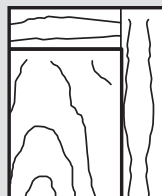

AUFSATZLEISTEN

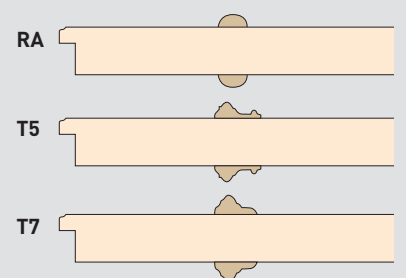

Echte Füllungstüren



Oberfläche: Kirschbaum Europäisch
Modell: S03 Chiemsee Gothik weiß
mit Messingsprosse Modell 12
Zarge: Kirschbaum Europäisch
Bekleidung Soft 120 mm
mit Wandanschlussleiste -
Form F



Oberfläche: Nussbaum Amerikanisch
 Modell: N33 Baden Susi Float Facettenschliff
 Zarge: Nussbaum Amerikanisch Bekleidung Soft 100 mm



Oberfläche: Erle
 Modell: G21 Baden
 Zarge: Erle Bekleidung Soft

FRANKEN

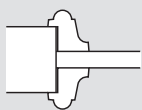
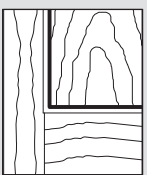

Leiste Form E

BADEN / ALBUCH

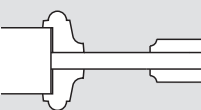
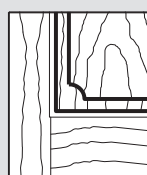
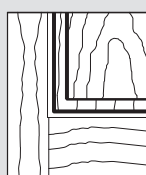

Leiste Form E

CHIEMSEE

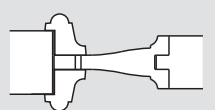
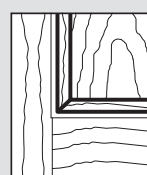

Leiste Form E



Oberfläche: Eiche Astig
Modell: Albuch G03
Glas: Bio 06
Zarge: Eiche Astig Soft

Modellvariationen

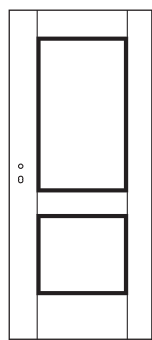

G01

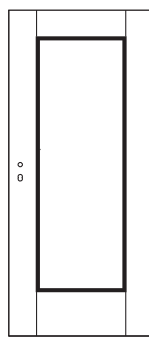

G02

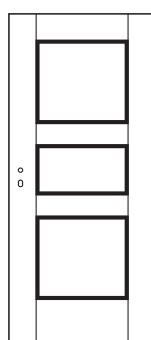

G08

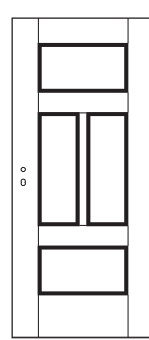

G09

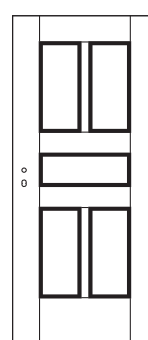

G10

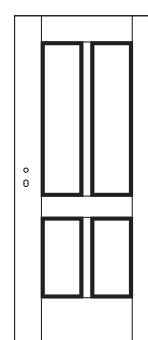

G21

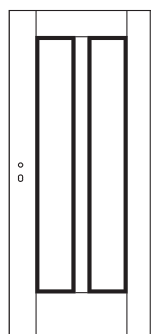

G48

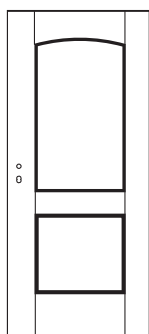

S01

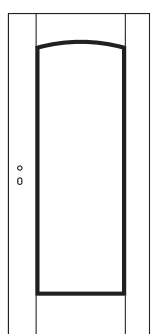

S02

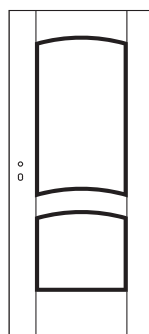

S15

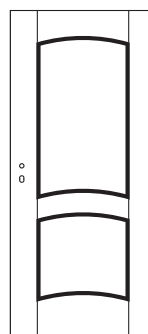

S17

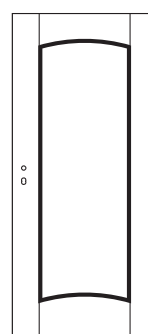

S18

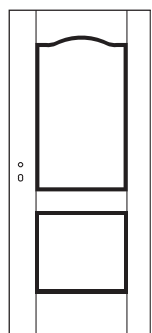

J01

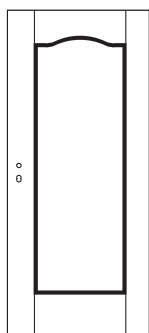

J02

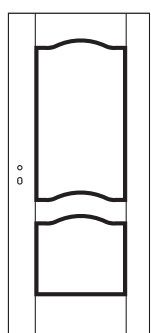

J15

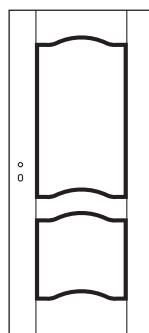

J17

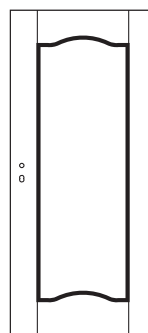

J18

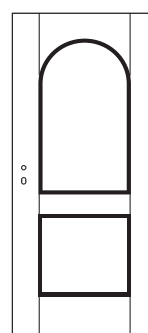

R01

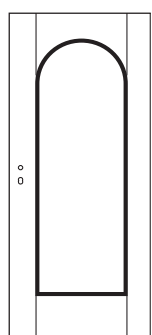

R02

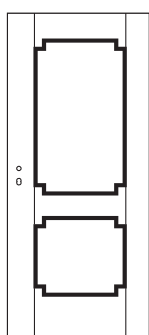

B01

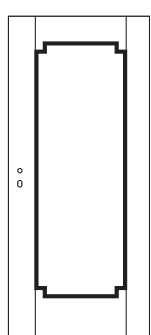

B02

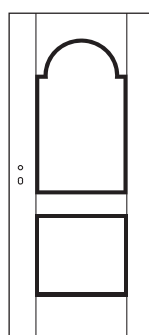

N01

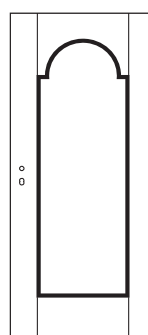

N02

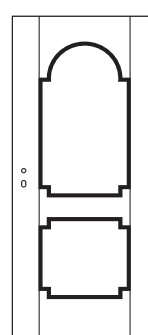

N31

Weitere Leistenformen



RG



GT7



F



MG

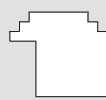

TG

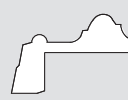

GT5



FB3



FB4

Handwerkliches Geschick





Applikationen



Detail: Rille

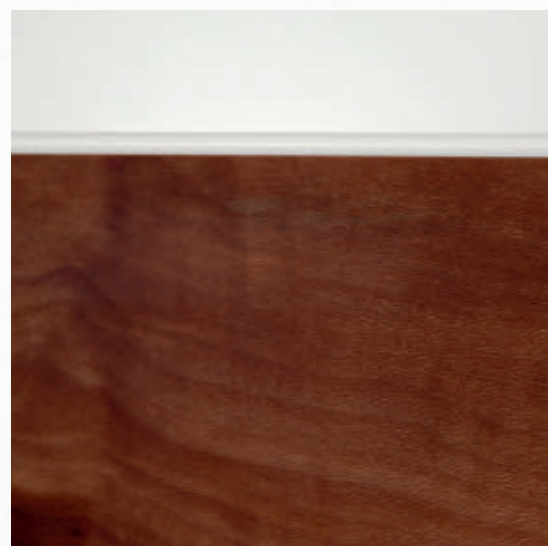

Oberfläche: RAL 9010
Modell: G00 A56 Rosenplatane,
Motivfräsung M56 A/Small
Zarge: RAL 9010 90 mm Bekleidung Soft 2

Modellvariationen



Oberfläche: RAL 9010

Modell: G00 A56 Bete, Motivfräsung M56 A/Small

Zarge: RAL 9010 90 mm Bekleidung Soft 2

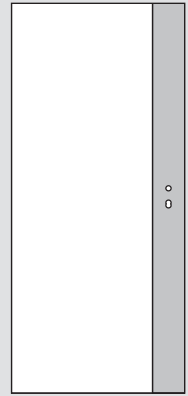

A21 + M1

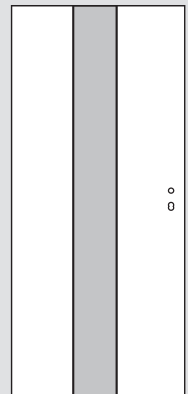

A24 + M62

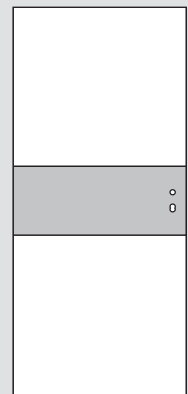

A56 + M56

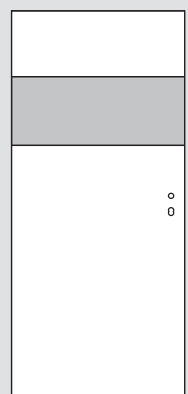

A58 + M58

Motivfräsungen

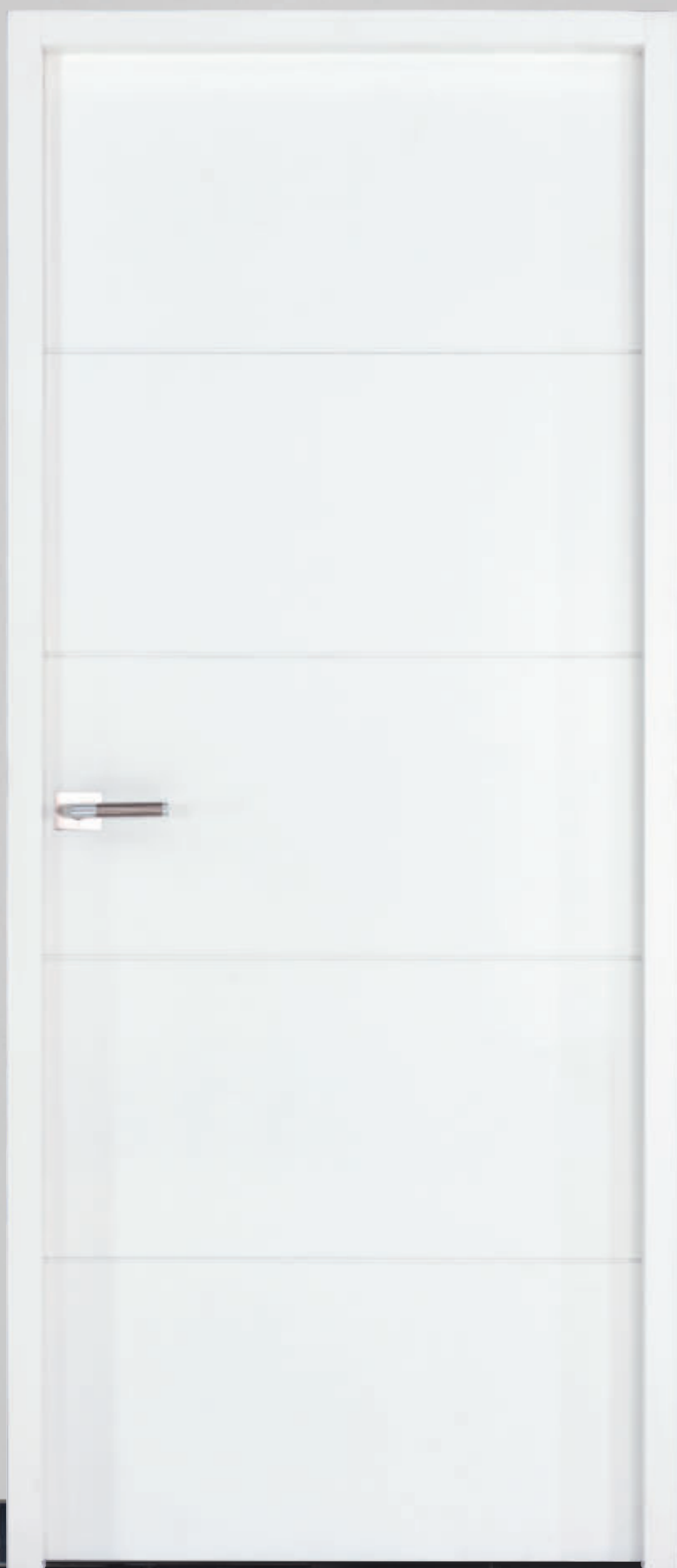

Oberfläche: RAL 9010
Modell: G00 M50 A/Small -
nur Drückerlochbohrung
Zarge: RAL 9010 Soft

Modellvariationen

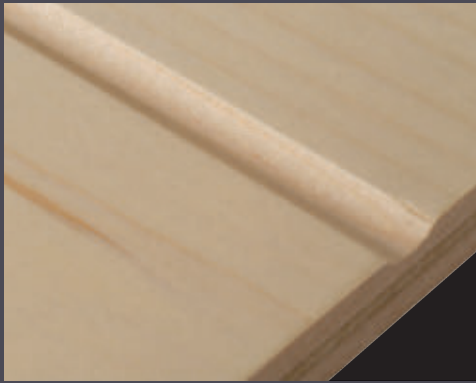

SMALL

Fräsrille 8 mm
Echtholz

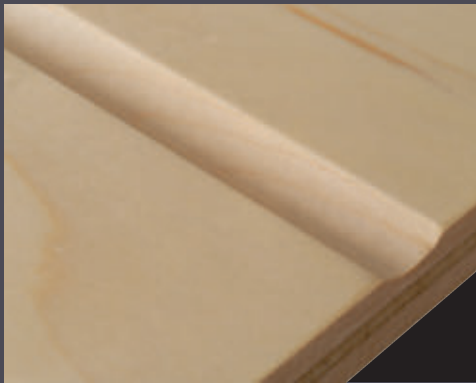

MEDIUM

Fräsrille 12 mm
Echtholz

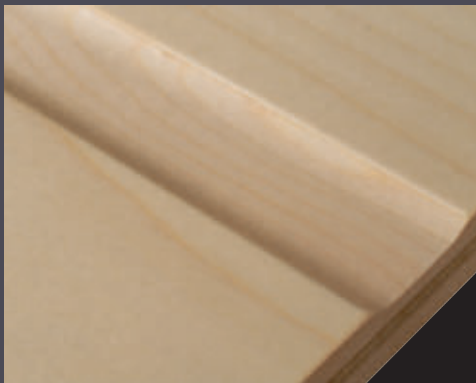

LARGE

Fräsrille 22 mm
Echtholz



SQUARE

Fräsrille 6 mm
Echtholz

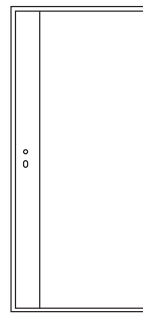

M1

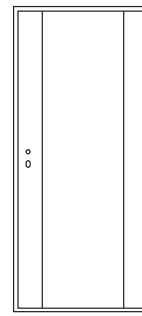

M2

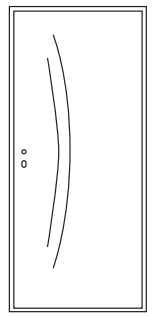

M3

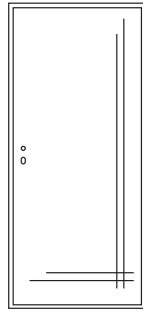

M9

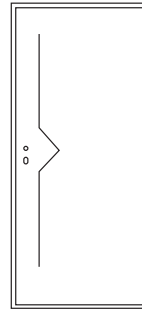

M15

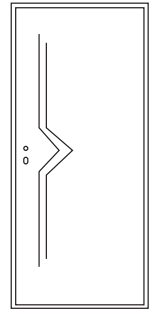

M16

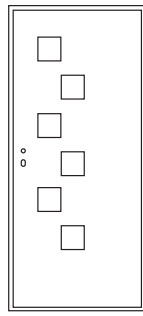

M29

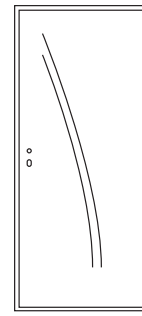

M30

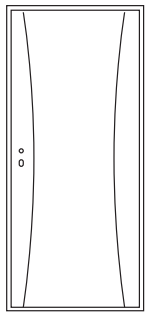

M33

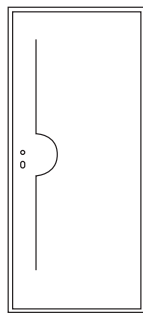

M42

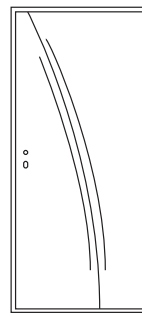

M45



M47

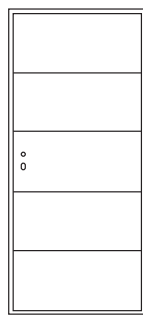

M50

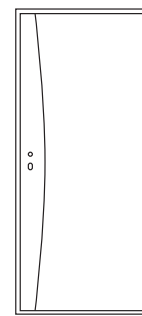

M52

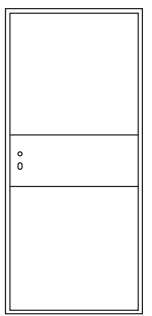

M56

Lisenen



Detail: Lisene Eiche Astig

Oberfläche: RAL 9010
Modell: G00 L50 Eiche astig
Zarge: RAL 9010 Soft



Oberfläche: RAL 9010
 Modell: G00 L50 Edelstahloptik
 Zarge: RAL 9010 Soft

Modellvariationen

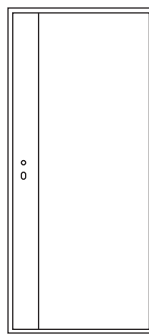

L1

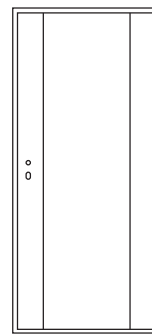

L2

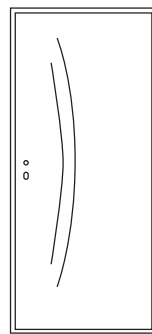

L3

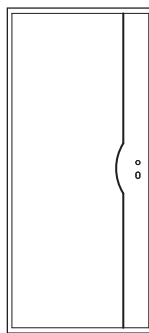

L7

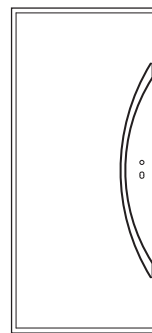

L9

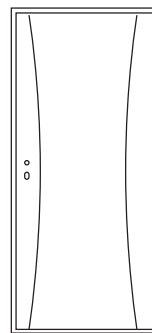

L33

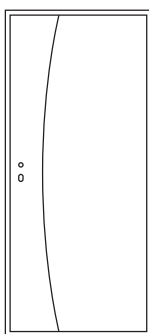

L48

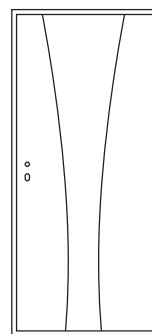

L49

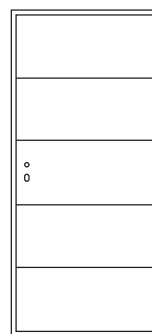

L50

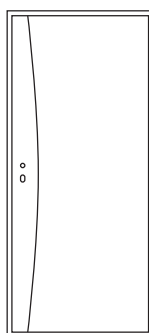

L52

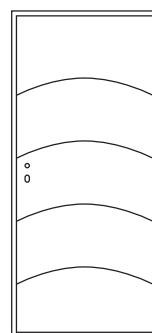

L53

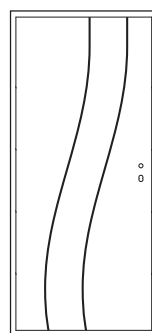

L54

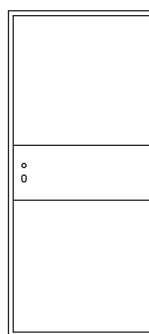

L56

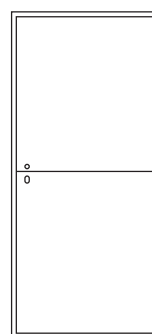

L57

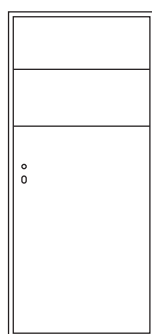

L58

New York





Oberfläche: RAL 9010
 Modell: New York 20 Magnettafel
 Zarge: RAL 9010 80 mm Bekleidung Soft 2
 Drücker: SMT3



Oberfläche: RAL 9010
 Modell: New York 20 Rostoptik
 Zarge: RAL 9010 80 mm Bekleidung Soft 2
 Drücker: SMT3

Die Türe mit der auswechselbaren Einlage!

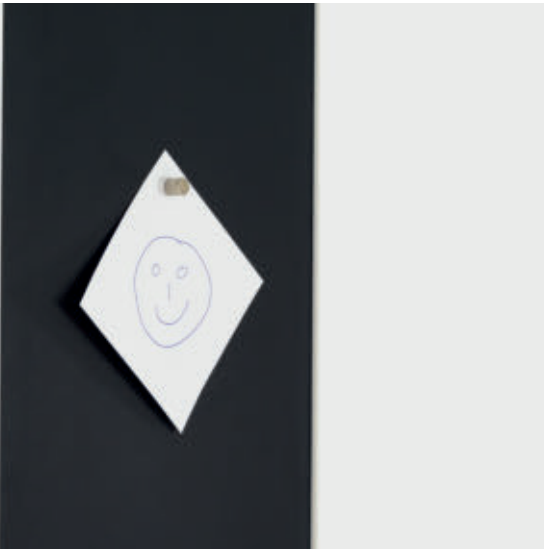

New York



Oberfläche: RAL 9010
Modell: New York 10 S
Einlage: Fichte Altholz längs
Zarge: RAL 9010 Bekleidung Soft



Oberfläche: RAL 9010
 Modell: New York 10 S
 Einlage: Titan quer
 Zarge: RAL 9010 Bekleidung Soft



Oberfläche: RAL 9010
 Modell: New York 10 S
 Einlage: Calisto längs
 Zarge: RAL 9010 Bekleidung Soft

weitere auswechselbare Einlagen möglich z.B.

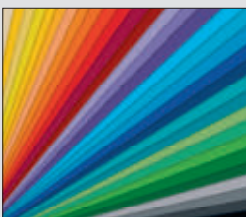

HPL



Spiegel

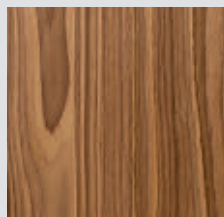

Farbfurnier

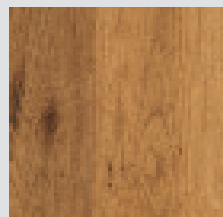

verschiedene Holzarten, längs- oder querfurniert

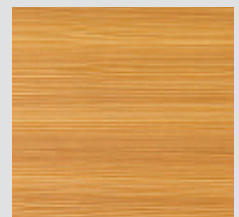

Handwerkliches Können,
kombiniert mit modernster Technik,
ergibt ein einmaliges Produkt.

Eine KONOLD Türe.





Blockrahmen



Blockrahmen mit zwei Seitenteilen in RAL lackiert
mit Türe G00 Altholz Eiche geölt



Blockrahmen mit Seitenteil Canadisch Ahorn
Konglas 20 in Vogelaugenahorn nur Drückerlochbohrung
Glas Float mit Motiv Alesia Sandgestrahlt

Blockrahmen



Blockrahmen mit einem Seitenteil in RAL 9010 lackiert
mit Türe in RAL 9010

Modellvariationen

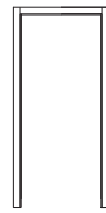

Blockrahmen



Blockrahmen
GEHO

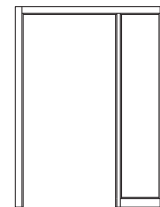

Blockrahmen
BR 1 Seitenteil

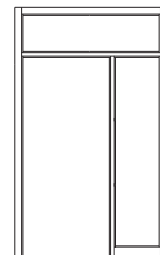

Blockrahmen
BR 1 Seitenteil
GEHO

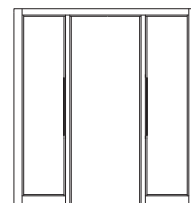

Blockrahmen
BR 2 Seitenteile

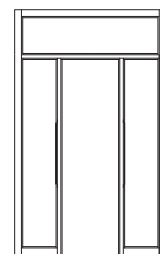

Blockrahmen
BR 2 Seitenteile
GEHO

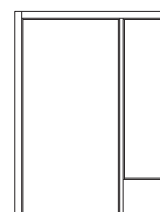

Blockrahmen
BR mit Sondersockelhöhe



Blockrahmen RAL schwarz mit
Türe G00 Altholz Eiche geölt
nur Drückerlochbohrung

Raumspartüre

stumpf mit Falz



KOHO 301 WC
mit Fallenfeststellung



Oberfläche: Eiche Astig
Modell: Naomi mit LA
Glas: Float (Glasleiste FB 4)
Zarge: Eiche Astig

Raumspartüre gefälzt



Oberfläche: Eiche Astig
Modell: Naomi nur Drückerlochbohrung
Zarge: Eiche Astig

Raumspartüre mit Teilung 1/3 zu 2/3

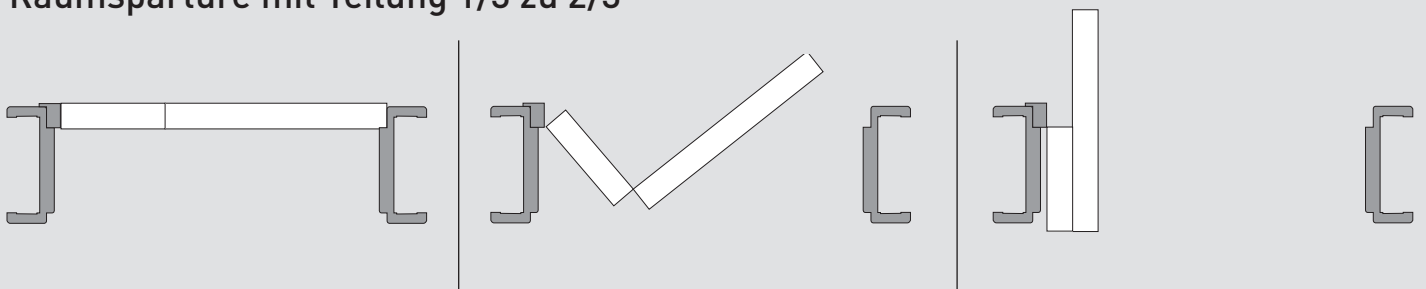

Drücker

Drücker mit 2 mm starker Flachrosette

Rosettenform rund, quadrat oder rechteckig frei wählbar



KOHO 1



KOHO 10



KOHO 2



KOHO 11



KOHO 3



KOHO 12



KOHO 4



KOHO 13



KOHO 5



KOHO 15



KOHO 6



KOHO 16



KOHO 7



KOHO 17



KOHO 8



KOHO 9

Drücker mit ca. 10 mm starker Rosette



KOHO 100



KOHO 140 Edelstahl



KOHO 102

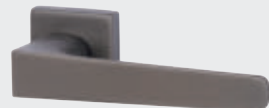

KOHO 140 Black Stone



KOHO 103



KOHO 143 Kupfer



KOHO 105



KOHO 144 Bronze Antik



KOHO 110



KOHO 144 Eisen Antik



KOHO 117



KOHO 144 Stahlgrau



KOHO 134



KOHO 145
Bronze
Antik

KOHO 145
Eisen
Antik



KOHO 136



KOHO 137



KOHO 145
Stahlgrau

Besondere Drücker

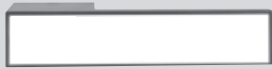

STRAIGHT



STRAIGHT WC



KOHO 300 WC



KOHO 301 WC

Smart Touch System aufgesetzt

Alleine durch Berühren des feststehenden, aufgesetzten Griffes wird ein Impuls an das Schloß gesendet und die Schloßfalle eingezogen. Türblätter werden ohne Schlüsselbohrung ausgeführt, bei WC ist ein Schließknochen innen zusätzlich enthalten (mit Not- und Gefahrenfunktion).

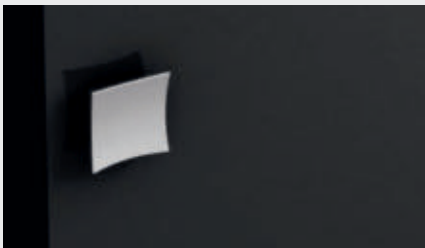

SMT 1



SMT 2



SMT 3



SMT 4



SMT 5

Smart Touch System eingelassen

Alleine durch Berühren der eingelassenen Griffmuschel wird ein Impuls an das Schloß gesendet und die Schloßfalle eingezogen. Türblätter werden ohne Schlüsselbohrung ausgeführt, bei WC ist ein Schließknochen innen zusätzlich enthalten (mit Not- und Gefahrenfunktion).

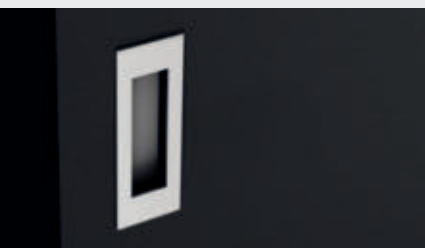

SMT 6

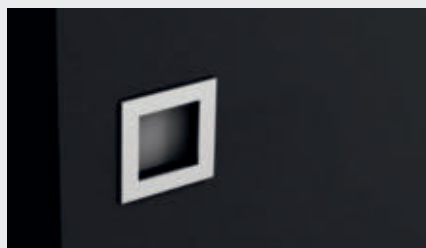

SMT 7



SMT 8

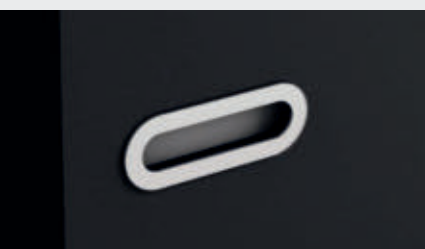

SMT 9



SMT 10

Bekleidungsformen Gefälzt

Eckig

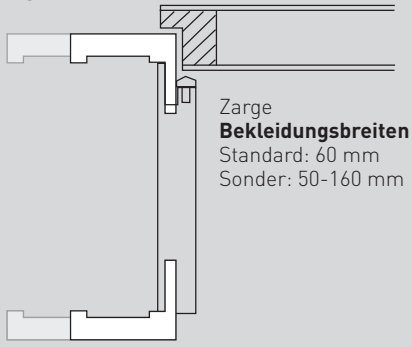

Zarge
Bekleidungsbreiten
 Standard: 60 mm
 Sonder: 50-160 mm

Soft

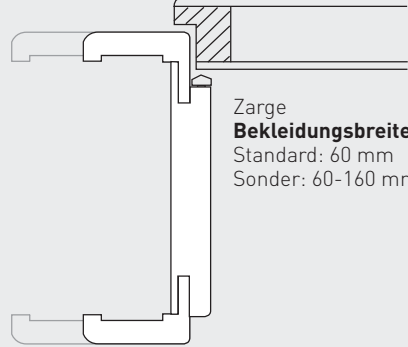

Zarge
Bekleidungsbreiten
 Standard: 60 mm
 Sonder: 60-160 mm

Soft 2

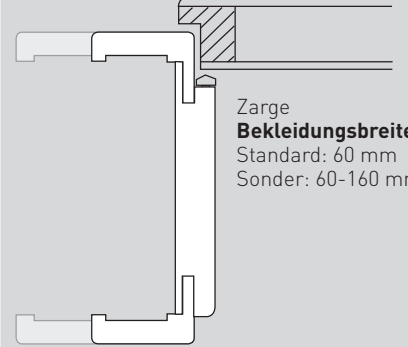

Zarge
Bekleidungsbreiten
 Standard: 60 mm
 Sonder: 60-160 mm

BEFA

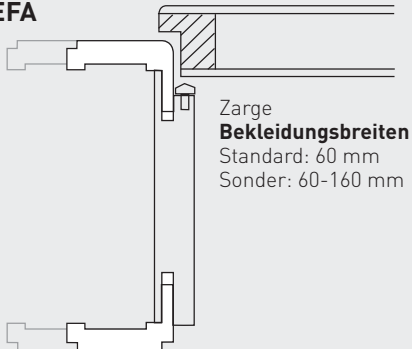

Zarge
Bekleidungsbreiten
 Standard: 60 mm
 Sonder: 60-160 mm

Bebo

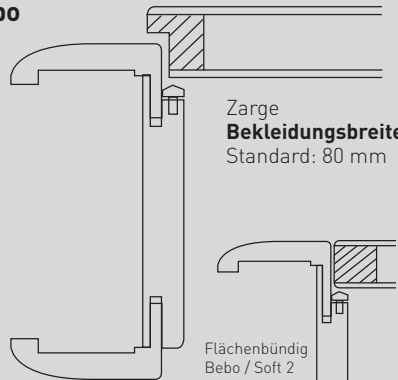

Zarge
Bekleidungsbreiten
 Standard: 80 mm

Flächenbündig
 Bebo / Soft 2

Beka

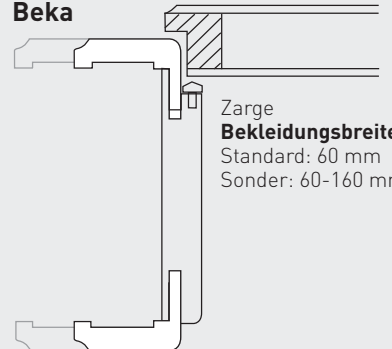

Zarge
Bekleidungsbreiten
 Standard: 60 mm
 Sonder: 60-160 mm

Bekleidungsformen Stumpf

Flächenbündig / Eckig

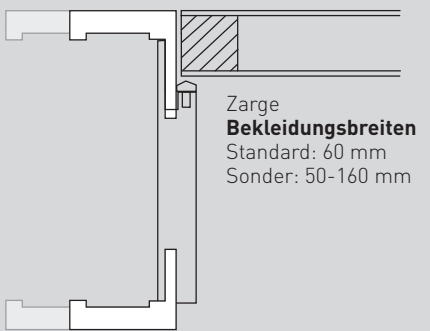

Zarge
Bekleidungsbreiten
 Standard: 60 mm
 Sonder: 50-160 mm

Flächenbündig / Soft

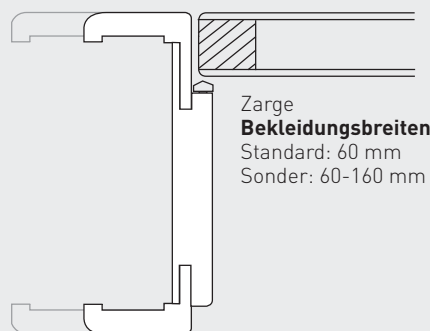

Zarge
Bekleidungsbreiten
 Standard: 60 mm
 Sonder: 60-160 mm

Flächenbündig / Soft2

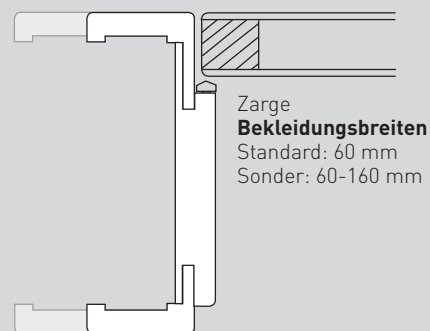

Zarge
Bekleidungsbreiten
 Standard: 60 mm
 Sonder: 60-160 mm

Furnierart und Furnierrichtung

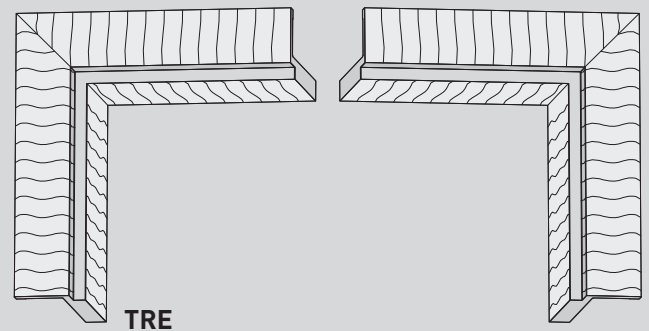
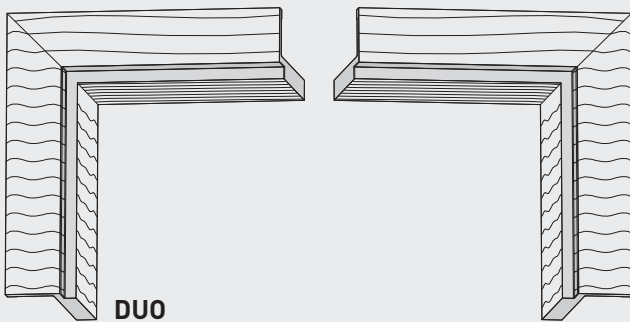
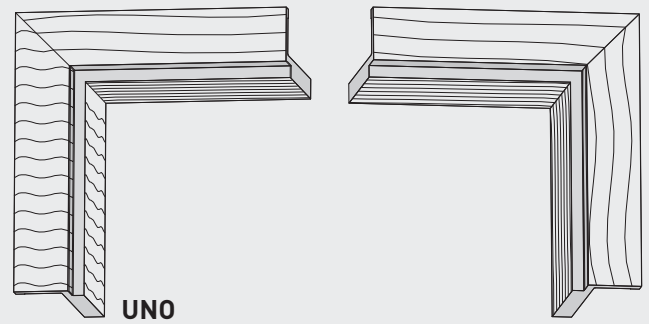
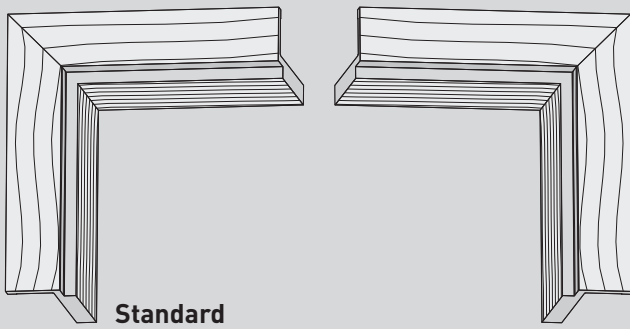









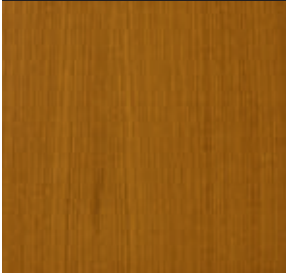
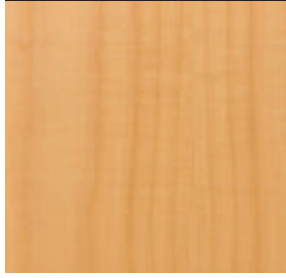

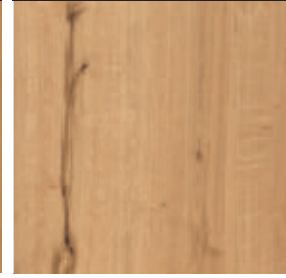





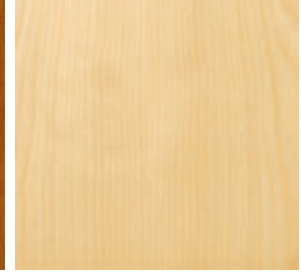

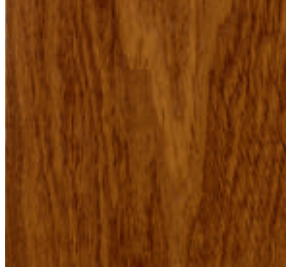

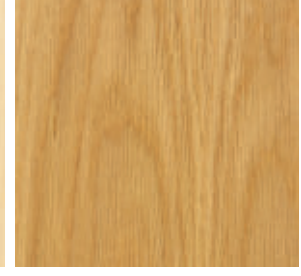

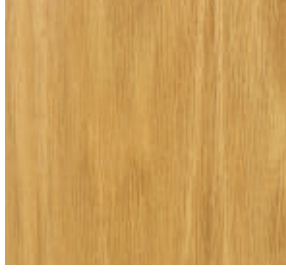

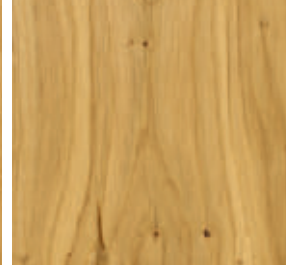
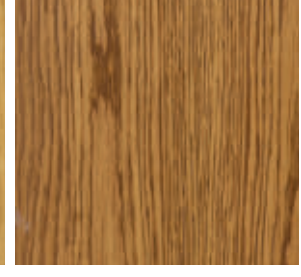
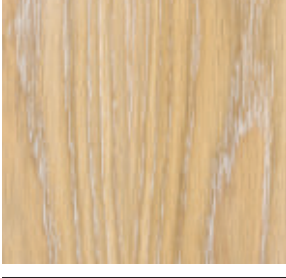



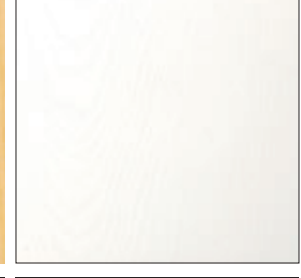



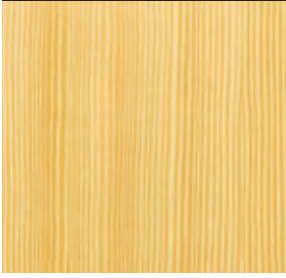

Entdecken Sie auch unsere weiteren individuellen Produkte aus den Bereichen

- Schiebetürelemente
- Wandbündige Elemente
- Rund- und Segmentbögen
- Dachschrägelemente
- Pendeltürelemente
- Türrohlinge
- HPL-Türelemente
- Renovierungselemente
- Windfangelemente
- Technische Elemente
 - Schallhemmend
 - Rauchhemmend
 - Wärmedämmend
 - Feuerhemmend
 - Einbruchhemmend

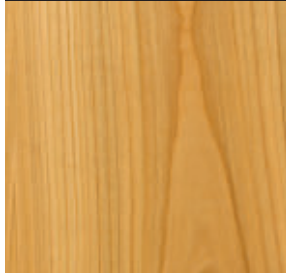
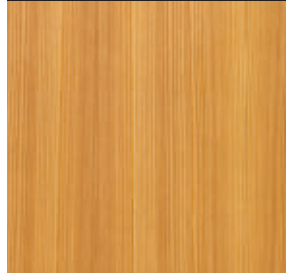
und noch vieles mehr!

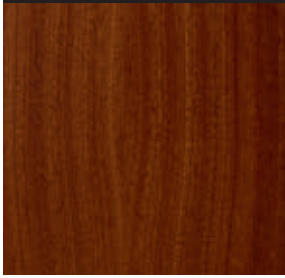
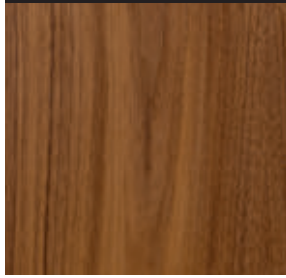
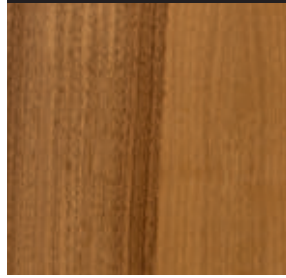
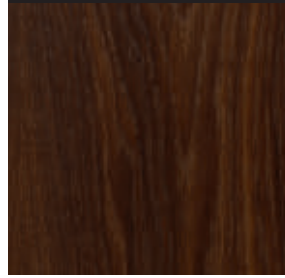
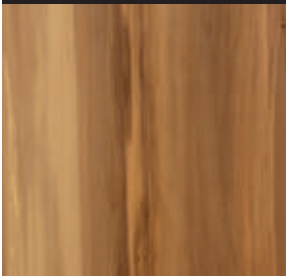
Furnierauswahl

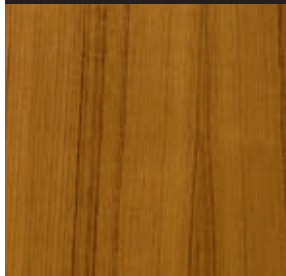
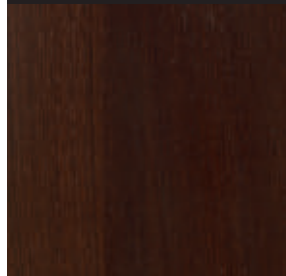
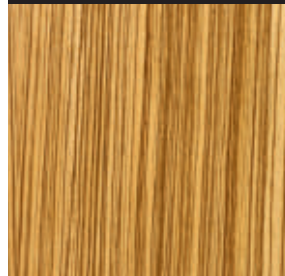
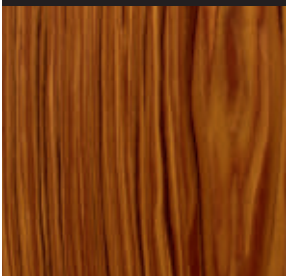
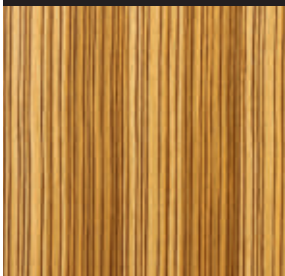
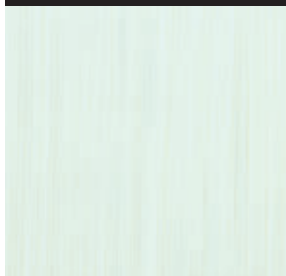
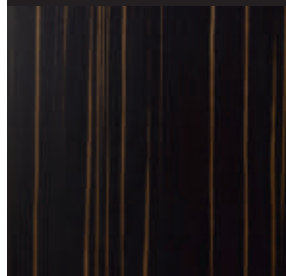
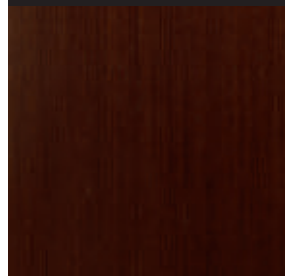
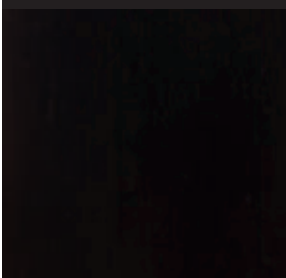
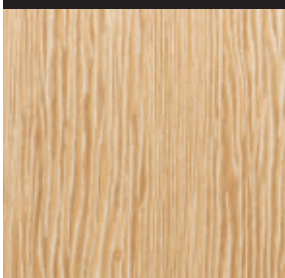
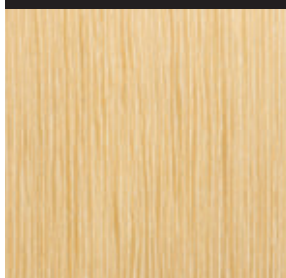
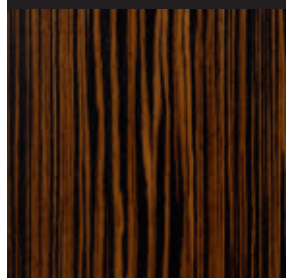
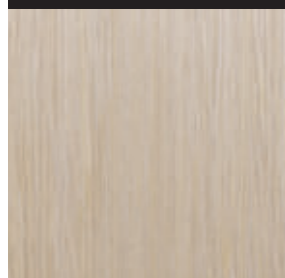
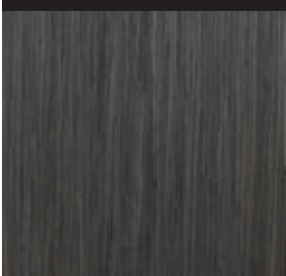
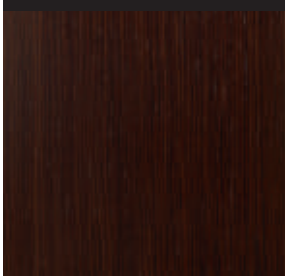
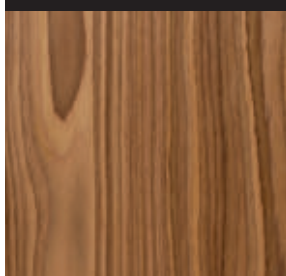
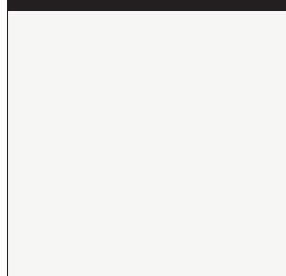
Afromosia 	Ahorn gedämpft 	Almeiche mattlack 	Altholz Eiche geölt 	Altholz Fichte geölt 
Anigre 	Bambus Caramel schmal 	Bergeiche 	Bete 	Birke 
Birnbaum 	Brauneiche 	Buche 	Canadisch Ahorn 	Eiche Amerikanisch 
Eiche Amerikanisch geölt 	Eiche Amerikanisch mattlack 	Eiche Astig 	Eiche Astig mattlack 	Eiche geb KP43 
Eiche gekalkt 	Eiche weiss mattlack 	Erle 	Esche 	Esche GEPO 5859 
Esche OFPO 5859 	Fichte 	Fichte astig 	Kernbuche 	Kernesche 

Kiefer 	Kirschbaum Amerikanisch 	Kirschbaum Europäisch 	Lärche 	Limba 
Macore 	Mahagoni 	Nussbaum Amerikanisch 	Nussbaum Französisch 	Raucheiche mattlack 
Red Gum (Satin Nuss) 	Rüster 	Teak 	Wenge 	Zebrano 
Farbfurnier Callisto 	Farbfurnier Corot 	Farbfurnier Eris 	Farbfurnier Jupiter 	Farbfurnier Mars 
Farbfurnier Merkur 	Farbfurnier Orcus 	Farbfurnier Pholus 	Farbfurnier Pluto 	Farbfurnier Saturn 
Farbfurnier Titan 	Farbfurnier Uranus 	Farbfurnier Venus 	RAL 9010 / 9016 	RAL / NCS Sonderfarbtöne 

Design by KONOLD – Designschutz nach Urheberrecht und gemäß Artikel 1 Abs. 2a) Gemeinschaftsgeschmacksmusterverordnung. Alle in diesem Katalog abgebildeten Designs unterliegen dem "Design by Konold"
Designschutz und sind urheberrechtlich geschützt. Farb- und Strukturabweichungen sind durch drucktechnische Wiedergabe möglich. Irrtümer und Änderungen vorbehalten. **Stand Mai 2019**.



KONOLD Härtsfelder Holzindustrie GmbH
Oberer Weiler 19
89561 Dischingen-Katzenstein
Tel: 07326 / 9600 - 0
Fax: 07326 / 9600 - 335
info@konold.com